

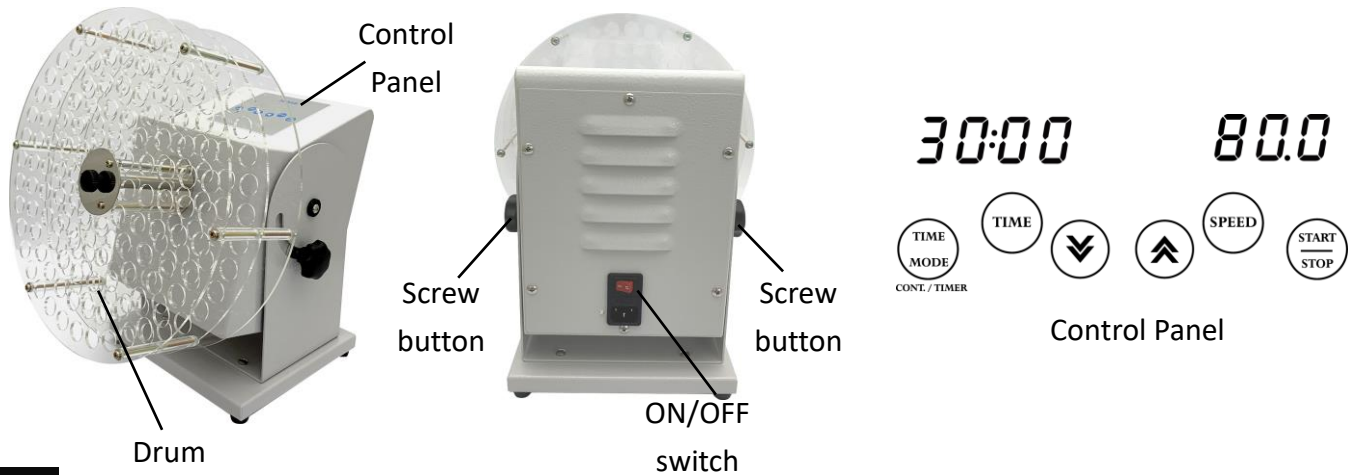









INSTRUCTION MANUAL FOR SUSPENSION ROTATOR SM-3600





Warnings:

- * Do not remove the mixer during operation.
- * Place the instrument securely away from the edge of bench to avoid the mixer falling off the bench top.
- * Do not disassemble the instrument by yourself. In the event of a malfunction, the unit should be repaired by a qualified technician. Before repairing, turn off the power.

Steps:

1. Place the rotator on a flat surface. Loosen two "Screw Button" to adjust the angle of the "Drum". Insert the tubes into the "Drum" in a symmetrical position.
2. Turn on the 'Power Switch' behind the machine. First, the SPEED and TIME display will show the speed and time value that you set last time. If the previous timed mode setting is Cont. mode (Continuous mode), you will see 'cont' on TIME display.
3. Setting time: Press the  key to select the time mode (Timed mode or Continuous mode).
 - 3.1 If the continuous mode is selected, the TIME display will show 'cont'.
 - 3.2 If the timer mode is selected, the previous setting value will show on the TIME display.
 - 3.2.1 Press  key, and the digits on the TIME display is flashing. (Time display is Hour: Minute; for the last one minute, it will display the remaining seconds)
 - 3.2.2 Press  key or  key to adjust the value.
 - 3.2.3 Press  key or any other keys to save the time value.
4. Setting speed:
 - 4.1 Press  key, and the digits on the SPEED display is flashing.
 - 4.2 Press  key or  key to adjust the value.
 - 4.3 Press  key or any other keys to save the speed value.

5. Press  key to start the machine. During the operation, you can press  key to stop the machine anytime.
6. Containers can be loaded and unloaded during the machine rolling.

Maintenance and care:

Keep the machine clean all the time, so no routine maintenance is required. Cleaning can be done with a damp cloth. Avoid the use of solvents as they may damage the machine housing.

Circuit Diagram:

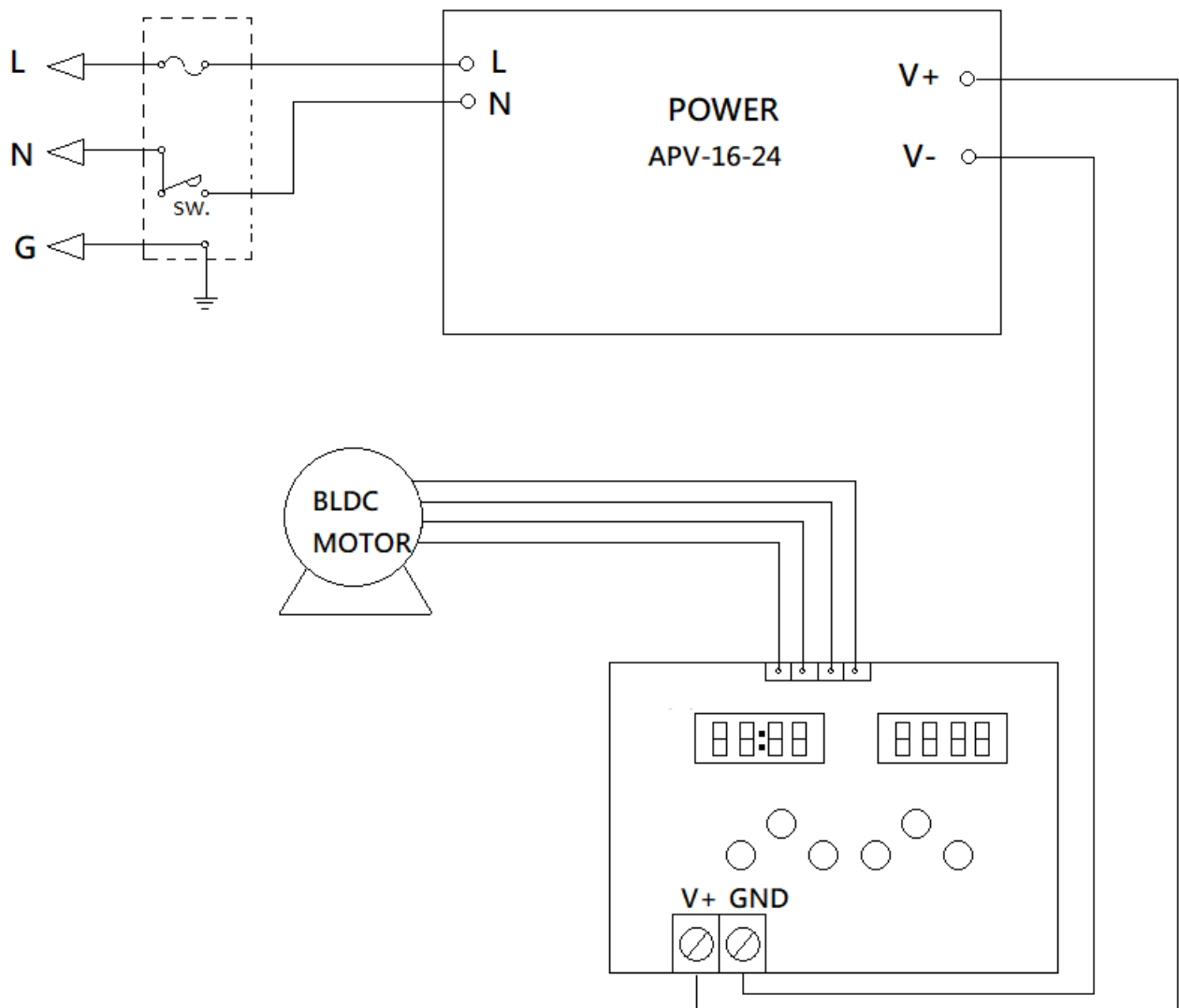

Service Manual

Troubleshooting Guide

Caution: Always disconnect the power cord before troubleshooting.

Trouble	Cause	Remedy
Instrument inoperative	Power cord not connected to outlet.	Plug in the power cord.
	Dead power output.	Change to different output.
	Fuse blown.	Change a new fuse.
	Defective electronic component.	Contact your distributor for repair.
Error message: run	Before the motor stops completely, turn off the 'Power Switch' behind the machine.	Turn on the 'Power Switch' behind the machine, after the motor stops completely.
Don't rotate	Power is not on.	Turn on the 'Power Switch' behind the machine.
	Start/Stop key is not pressed.	Press the Start/Stop key.
	Belt is broken	Contact your distributor for repair.
Don't rotate (Error message: Er-P)	PC board is broken. .	Contact your distributor for repair.
	Motor is broken.	Contact your distributor for repair.
Keep rotating when time is up	PC board is broken.	Contact your distributor for repair.
Speed is abnormal	PC board is broken.	Contact your distributor for repair.
No signal on LED DISPLAY	PC board is broken.	Contact your distributor for repair.

Remark: To clear the error message, please turn off the power.