

INSTRUCTION MANUAL FOR WATER BATH WB-500D & WB-1000D

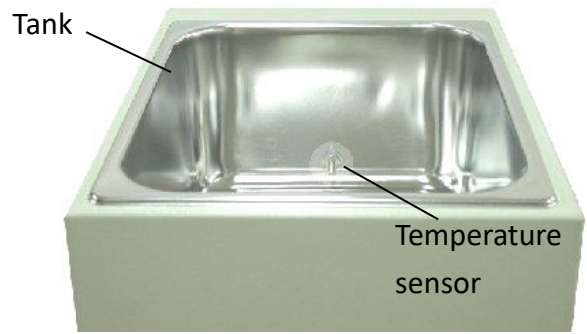

PID Controller

Power indicator
ON/OFF Button



Temperature sensor

Warnings:

- * The water in the tank is hot. Do not touch.
- * Do not remove the machine during operation.
- * Do not disassemble the machine by yourself. In the event of a malfunction, the machine should be repaired by a qualified technician. Before repairing, turn off the power.

Steps:

1. Connect with power supply. Please make sure the power voltage is the same as the voltage showing on the label stuck on the back of machine. You may see the 'Power indicator' becomes red.
2. Pour pure water (or distilled water) into the 'Tank' until water level covers a half height of the 'Tank'.
3. Press 'ON/OFF Button', then you may see the 'Power indicator' becomes green. Wait for about 5 seconds; you can see from the 'PID Controller', the present temperature value (PV) on the upper row and setting temperature value (SV) on the lower row.
4. Press 'Up Key' or 'Down Key' to adjust SV value and then press 'SET Key' to enter the value.
5. After finishing the work, please press 'ON/OFF Button' to turn off the power, and then the 'Power indicator' become red.

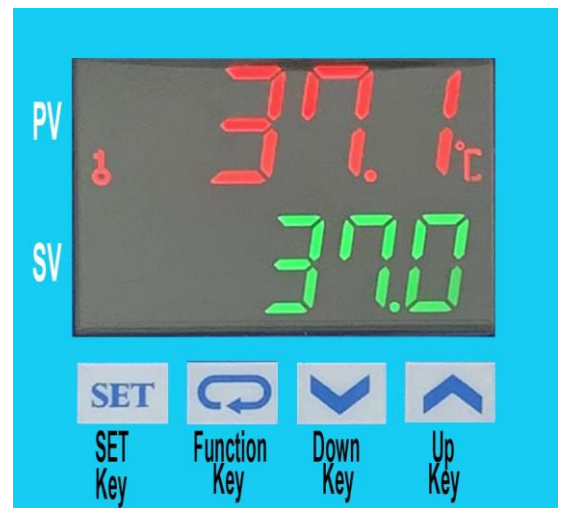

Caution:

If water level is under the bottom of the 'Temperature sensor', you must pour water into 'Tank' to cover the 'Temperature sensor'.

Maintenance and care:

1. Keep the machine clean all the time, so no routine maintenance is required. Cleaning can be done with a damp cloth. Avoid the use of solvents as they may damage the product.
2. For a long time no use, please pour out the water. And dry the tank on a clean cloth.

Other functions:

Note: Before executing other functions, please follow “5. Setting locking status” (c)to release the locking status. After executing other functions, please follow “5. Setting lock status” (a) and (b) to set the locking status to be LoC2.

1. Setting point alarm:

(a) Setting upper-limit point for the alarm: (when the difference between PV and SV is over upper-limit, the “Alarm Indicator “ (ALM1) will light up.)

(1) Press  four times. You will see **AL HI** in upper row and the setting value in lower row.

(2) Press Up or Down key to set value, and press **SET** to enter the value. Press **SET** again to be back the PV/SV display.

(3) The initial value is 4.

(b) Setting lower-limit point for the alarm: (when the difference between PV and SV is over lower-limit, the “Alarm Indicator “ (ALM1) will light up.)

(1) Press  five times. You will see **AL LL** in upper row and the setting value in lower row.

(2) Press Up or Down key to set value, and press **SET** to enter the value. Press **SET** again to be back the PV/SV display.

(3) The initial value is 4.

2. Setting temperature unit:

(a) Press **SET** more than 3 sec., until you see **LnPt** in upper row.

(b) Press  once. You will see **LPUIn** in upper row and the setting value in lower row.

(c) Press UP or Down key to set temperature unit to be “C” or “F”, and press **SET** to enter the value. Press **SET** again to be back the PV/SV display.

(d) The initial value is C.

3. Setting PV shift (offset) value: (if the PV value is not correct, you can use this function to correct the PV value.)

(a) Press **SET** once, and then you will see **AL** in upper row.

(b) Press  seven times, and you will see **Puof** in upper row and the setting value in lower row.

(c) Press Up or Down key to set shift value , and press **SET** to enter the value. Press **SET** again to be back the PV/SV display.

(d) The initial value is 0.

4. Setting Auto-tuning function:

(a) Press Up or Down key to set SV value to be auto-tuning. Press **SET** to enter the value.



(b) Press **SET** once.

(c) You will see **AL** in upper row and the setting value in lower row.

(d) Press UP or Down key to choose “ON” to start or “OFF” to close auto-tuning function. When auto-tuning function is on, you will see the “AT” indicator blanking. Once the auto-tuning function finish, the light of “AT” will extinguish.

(e) The initial value is OFF.

Note: (Auto-tuning function is that PID controller can depended on the ambient air temperature to find the best way to reach the setting temperature and let the setting temperature keep stable.

5. Setting locking status:
- (a) Press  three times, and then you will see **LoL** in upper row and the setting value in lower row.
 - (b) Press Up or Down key to select the locking status. LoC1 can lock all settings ; LoC2 can lock others than SV. When OFF is selected, the lock function will be off. After selecting, press **SET** to enter the value. Press **SET** again to be back the PV/SV display.
 - (c) Press  and **SET** simultaneously, and you see **PEEP** in upper row. Press , and you will see 0000 in the low row and then press **SET**. The key symbol will disappear from the screen. Then the locking status is released.
 - (d) The initial value is LoC2.
6. During the process of setting values, you may press **SET** anytime to be back PV/SV value.

Circuit Diagram:

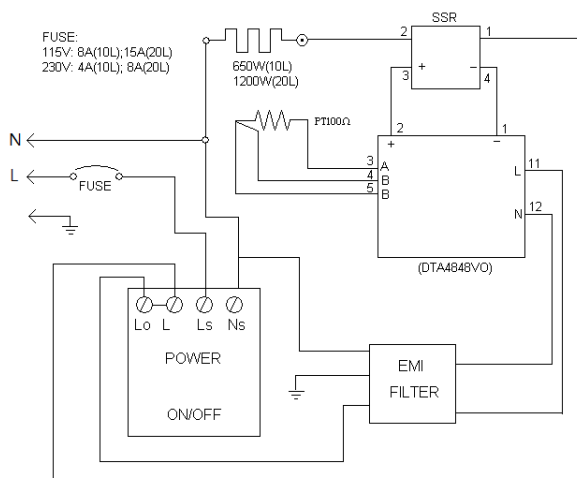

Troubleshooting Guide

Caution: Always disconnect the power cord before troubleshooting.

Trouble	Cause	Remedy
Instrument inoperative	Power cord not connected to outlet.	Plug instrument in..
	Dead power output.	Change to different output.
	Current is overload, so the no fuse breaker on the behind of themachine.	Push the button of the no fuse breaker to reset
Control head can't control the water temperature	Sensor is broken	Replacing a sensor
	PID controller	Replacing a PID controller
	Heater is broken	Replacing a heater
The key of PID controller can't work	The keys has been locked	Please refer to page 2, Other functions 5. (c) to release the lock status.
Temperature is not stable	The initial setting value is not suitable for the ambient air temperature where the machine is located	Please refer to page 2, Other functions 4. to set auto-tuning function to solve this problem.
PV value is not correct	User's calibration thermometer is different from the factory's calibration thermometer	Please refer to page 2, Other functions 3 to adjust PV value